

David Clark COMPANY
INCORPORATED

360 Franklin Street, Box 15054, Worcester, MA 01615-0054
TEL.: (508) 751-5800 E-Mail: sales@DavidClark.com FAX: (508) 753-5827

PARTS LIST
MODEL C35-08

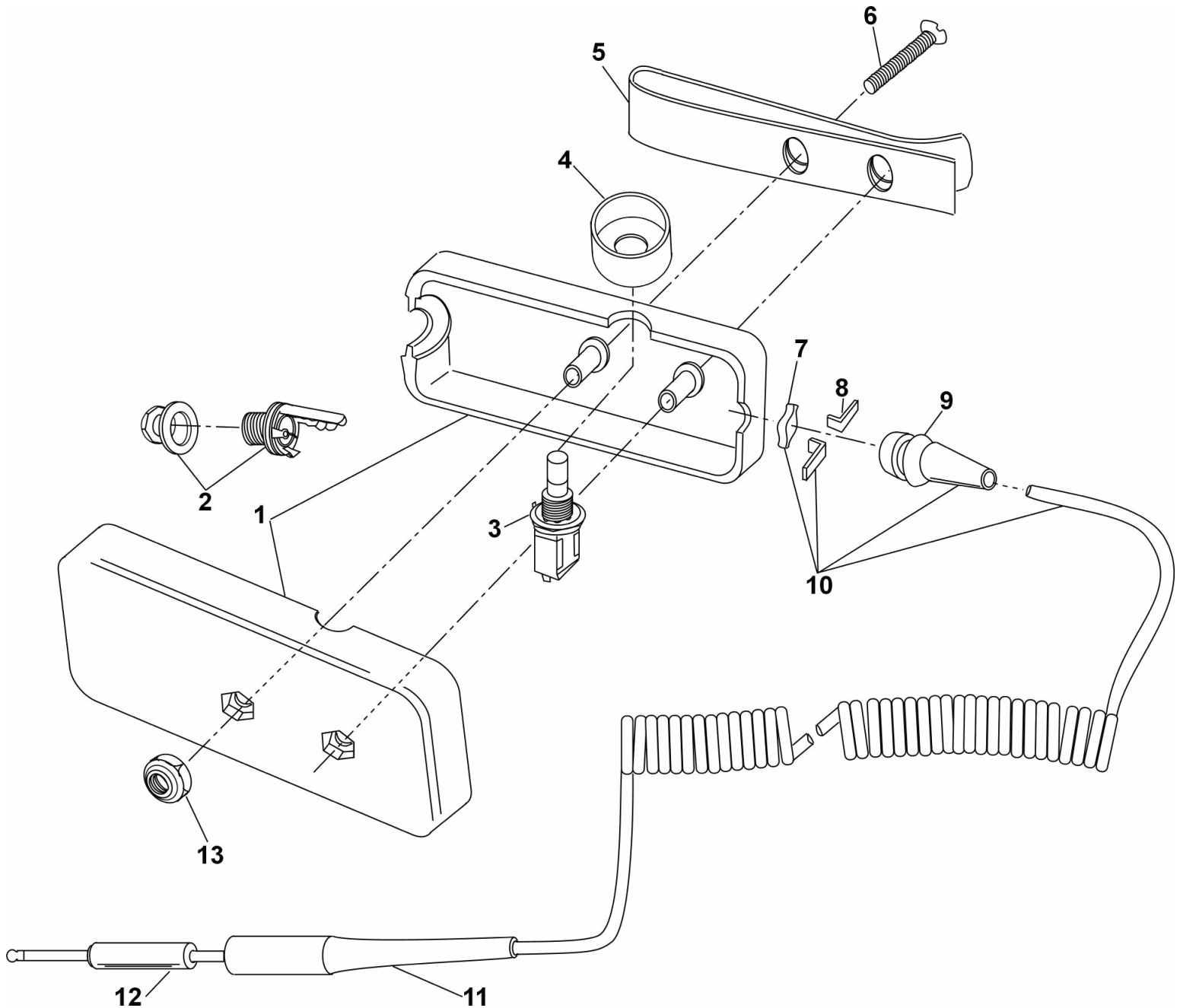

No.	Description	Part No.
1	Case	10815G-17
2	Headset Jack	09228P-03
3	Switch	26619P-13
4	Push Button Guard	26553P-01
5	Belt Clip	15368P-01
6	Screw (10/pk)	18900G-02
7	Circle Clamp (10/pk)	24433P-14

No.	Description	Part No.
8	Anti-Rotation Clip 10/pk	14176P-02
9	Grommet	14889P-01
10	Comm Cord Kit	18028G-98
11	Bend Relief Sleeve	17836P-03
12	Electrical Connector Kit	18900G-42
13	Nut (10/pk)	18900G-03

ELECTRICAL SCHEMATIC
MODEL C35-08

